

1 MTS 40-80 R38 D8.6



Screw spindle pump designed for pumping of cooling lubricants and cutting oils water/oil emulsion min. 3% for machine tool applications. The pump is designed to be mounted on top of tanks with pump immersed in the pumped liquid.

The pump has the following characteristics:

- High efficiency ensures very low heat input into the cooling lubricant.
- Axial thrust completely neutralised hydrostatically.
- Very wear resistant due specially hardened surfaces.
- D8.6 - mechanical shaft seal according to EN 12756.
- Power transmission via cast iron flexible coupling.

The motor is a 3-phase AC motor.

:	:	Emulsion
:	:	80 °C
:	:	20 °C
:	:	998.2 kg/m ³
:	가	: 3500 rpm
1	:	51.2 l/min
가:	:	D8.6
:	:	CE,EAC
:	:	60 °C
:	:	80 bar
:	:	SAE 1 1/2"
:	:	G 3/4" / SAE 1"
:	:	0 mm
:	:	FF300
IE	:	160MB
- P2:	:	IE2 - IE3
(P2):	:	11 kW
:	:	10.8 kW
:	:	60 Hz
:	:	3 x 220-277D/380-480Y V
:	:	36,0-30,0/20,8-17,2 A
cos phi -	:	580-890 %
:	:	0.89-0.83
:	:	3520-3550 rpm

: IE2 90,2% - IE3 91,0%
: 90.2-91.0 %
3/4 : 91.8 %
1/2 : 91.3 %
: 2
(IEC 34-5): 55 Dust/Jetting
(IEC 85): F
:
: 122 kg

MTS 40-80 R38 D8.6 60 Hz



MTS 40-80 R38 D8.6	
EAN	
가	3500 rpm
	51.2 l/min
1	D8.6
가:	CE, EAC
	A
	60 °C
	80 bar
	SAE 1 1/2"
	G 3/4" / SAE 1"
	0 mm
	FF300
	DRY
	Emulsion
	80 °C
	20 °C
	998.2 kg/m ³
	160MB
IE	IE2 - IE3
- P2:	11 kW
(P2):	10.8 kW
	60 Hz
	3 x 220-277D/380-480Y V
	36,0-30,0/20,8-17,2 A
	580-890 %
cos phi -	0.89-0.83
	3520-3550 rpm
	IE2 90,2% - IE3 91,0%
	90.2-91.0 %
3/4	91.8 %
1/2	91.3 %
	2
(IEC 34-5):	55 Dust/Jetting
(IEC 85):	F
	PTC
	87420001
Pos term	12 o'clock
	122 kg
	3 %
	38

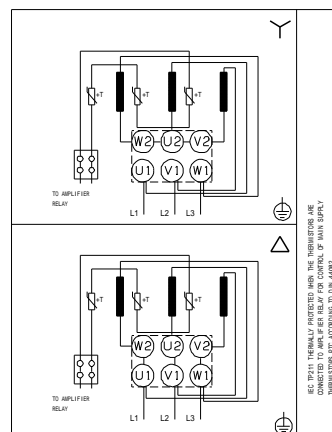
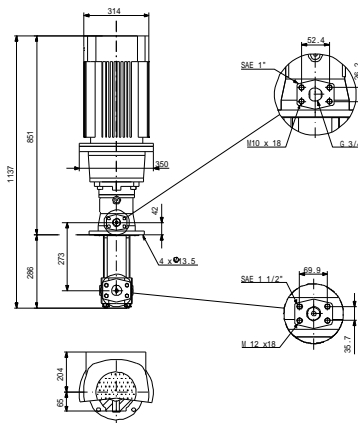
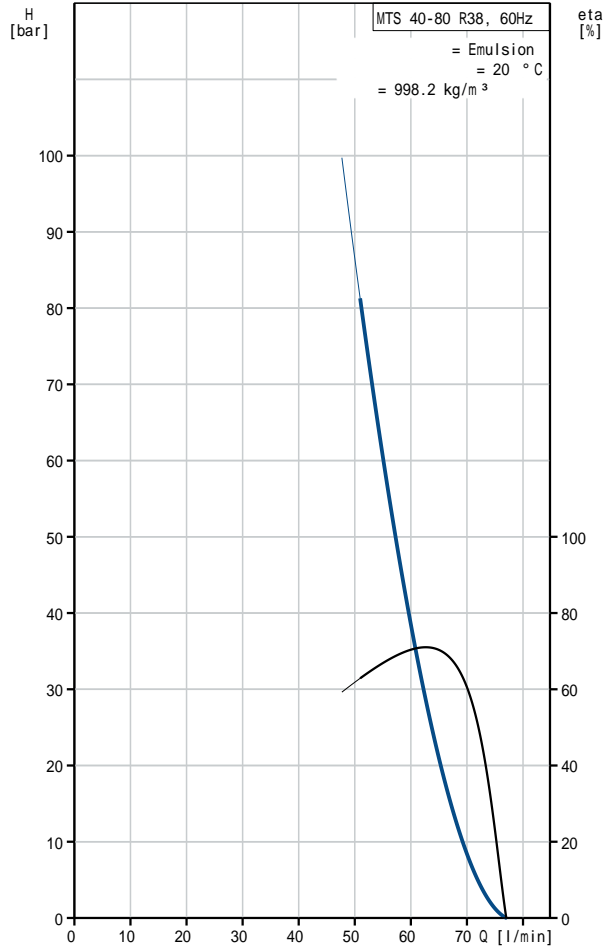

MTS 40-80 R38 D8.6 60 Hz

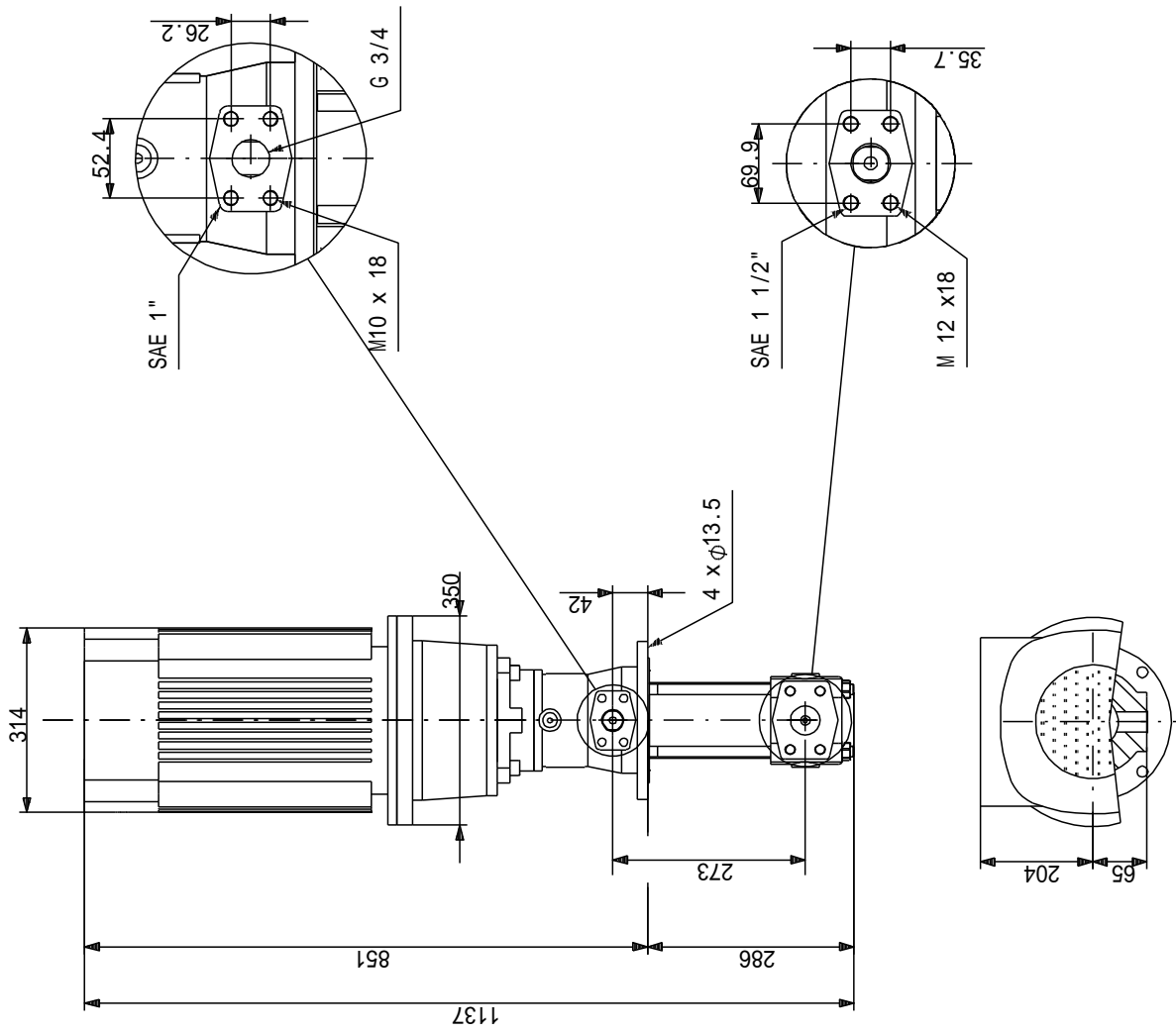

!

[mm]

MTS 40-80 R38 D8.6 60 Hz

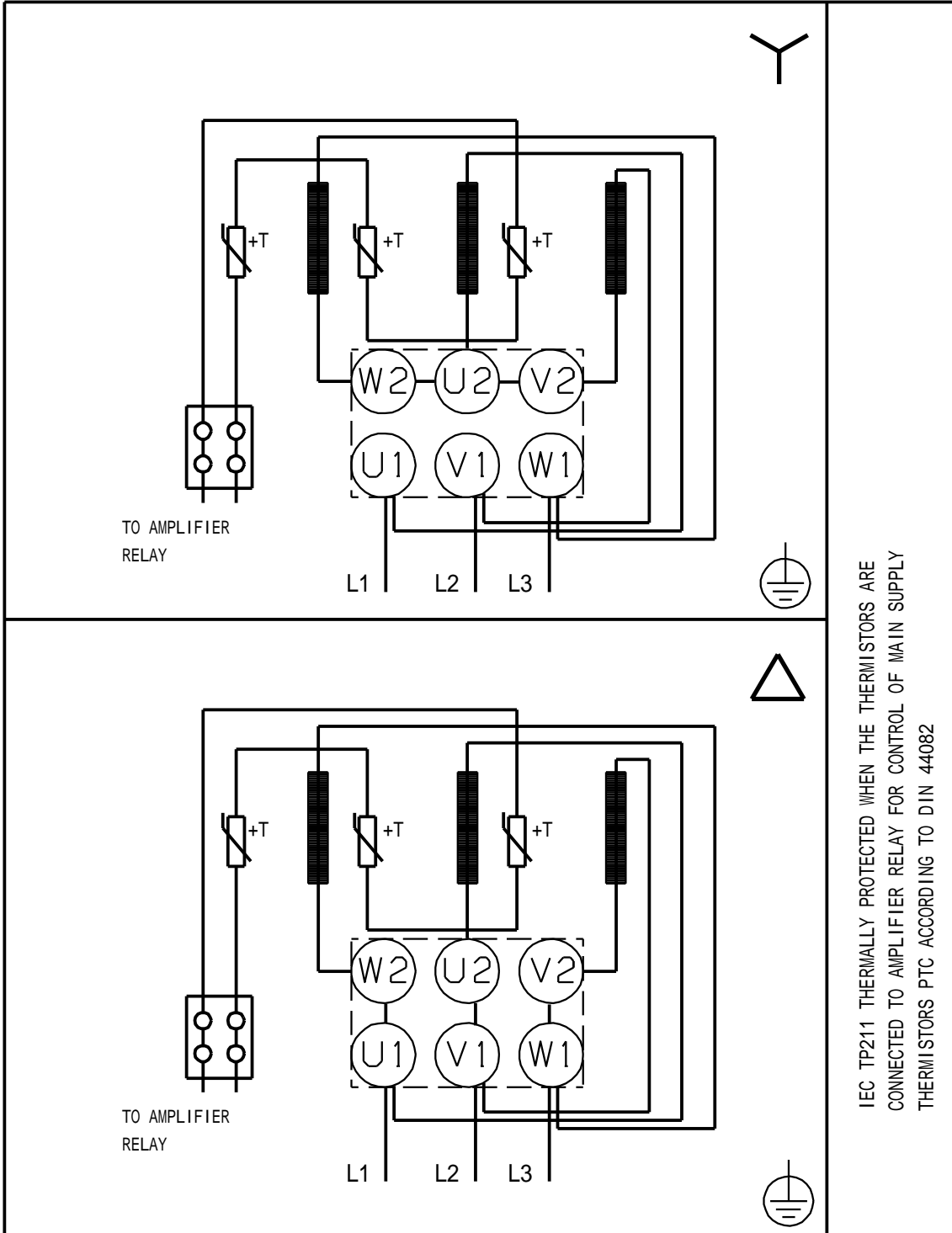

IEC TP211 THERMALLY PROTECTED WHEN THE THERMISTORS ARE
CONNECTED TO AMPLIFIER RELAY FOR CONTROL OF MAIN SUPPLY
THERMISTORS PTC ACCORDING TO DIN 44082