

1 MTS 140-90 R39 D8.6



Screw spindle pump designed for pumping of cooling lubricants and cutting oils water/oil emulsion min. 3% for machine tool applications. The pump is designed to be mounted on top of tanks with pump immersed in the pumped liquid.

The pump has the following characteristics:

- High efficiency ensures very low heat input into the cooling lubricant.
- Axial thrust completely neutralised hydrostatically.
- Very wear resistant due specially hardened surfaces.
- D8.6 - mechanical shaft seal according to EN 12756.
- Power transmission via cast iron flexible coupling.

The motor is a 3-phase AC motor.

:	:	Emulsion
:	:	80 °C
:	:	20 °C
:	:	998.2 kg/m ³
:	:	
:	가	: 3500 rpm
:	:	201 l/min
1	:	D8.6
가:	:	CE
:	:	
:	:	55 °C
:	:	90 bar
:	:	SAE 2"
:	:	G 1 1/4" / SAE 1 1/2"
:	:	0 mm
:	:	FF400
:	:	
IE	:	SIEMENS
:	:	NEMA Premium / IE3 60Hz
- P2:	:	45 kW
(P2):	:	40.1 kW
:	:	60 Hz
:	:	3 x 380-420D/660-725Y V
:	:	81,0-73,0/47,0-42,0 A
:	:	760-760 %
cos phi -	:	0.90
:	:	3555 rpm

:	:	IE3 94,2%
	:	94.2-94.2 %
3/4	:	94.3-94.3 %
1/2	:	93.7-93.7 %
:	:	2
(IEC 34-5):	:	55 Dust/Jetting
(IEC 85):	:	F
:	:	
:	:	416 kg

MTS 140-90 R39 D8.6 60 Hz

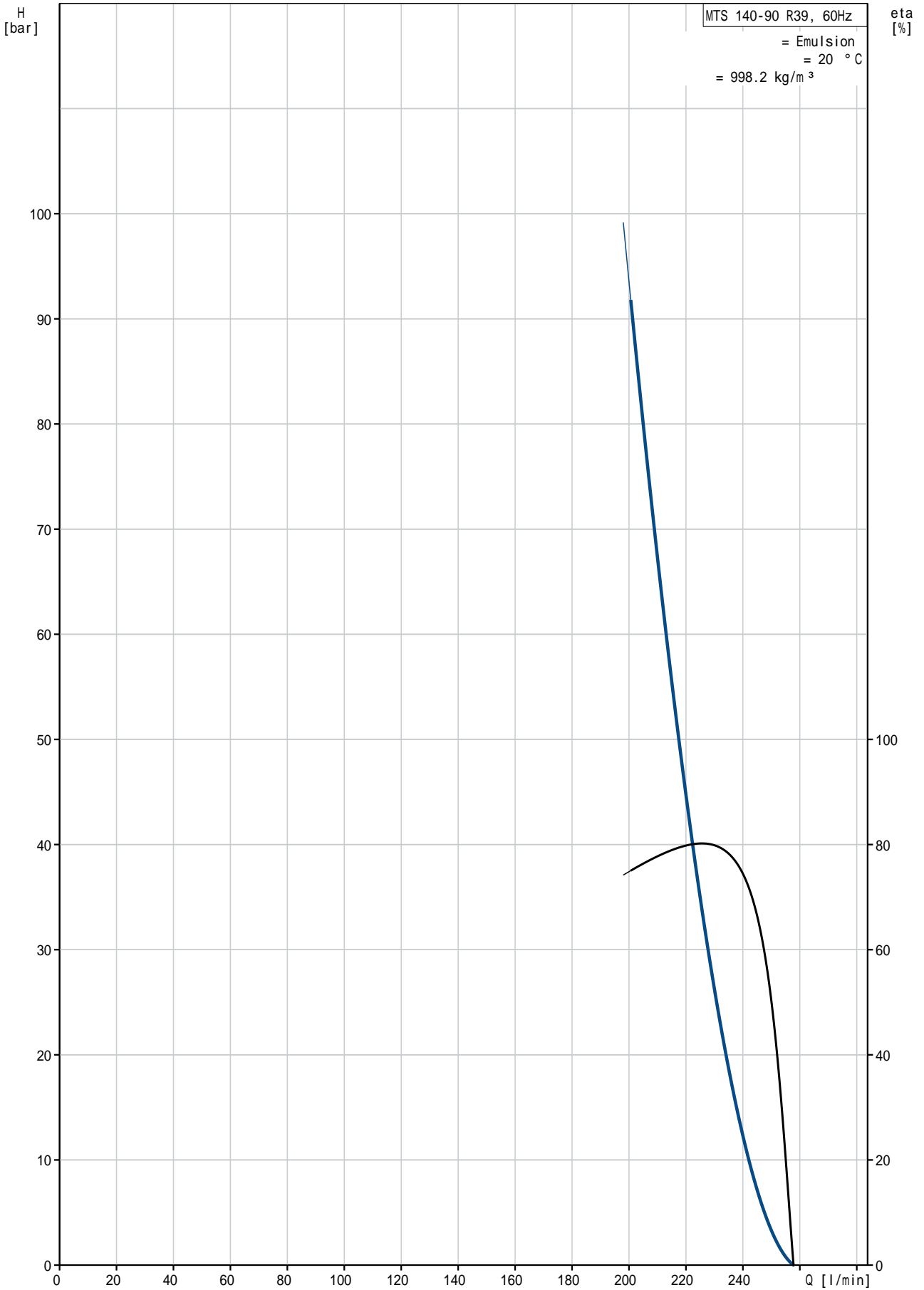

MTS 140-90 R39 D8.6	
EAN	
가	3500 rpm
	201 l/min
1	D8.6
가:	CE
	A
	55 °C
	90 bar
	SAE 2"
	G 1 1/4" / SAE 1 1/2"
	0 mm
	FF400
	DRY
	Emulsion
	80 °C
	20 °C
	998.2 kg/m ³
	SIEMENS
IE	NEMA Premium / IE3 60Hz
- P2:	45 kW
(P2):	40.1 kW
	60 Hz
	3 x 380-420D/660-725Y V
	81,0-73,0/47,0-42,0 A
	760-760 %
cos phi -	0.90
	3555 rpm
	IE3 94,2%
	94.2-94.2 %
3/4	94.3-94.3 %
1/2	93.7-93.7 %
	2
(IEC 34-5):	55 Dust/Jetting
(IEC 85):	F
	PTC
	83U15236
Pos term	12 o'clock
	416 kg
	3 %
	39

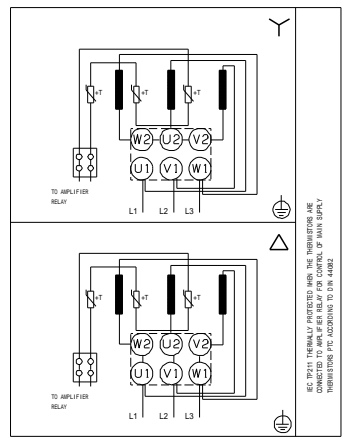
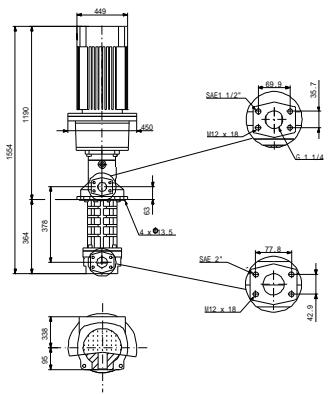
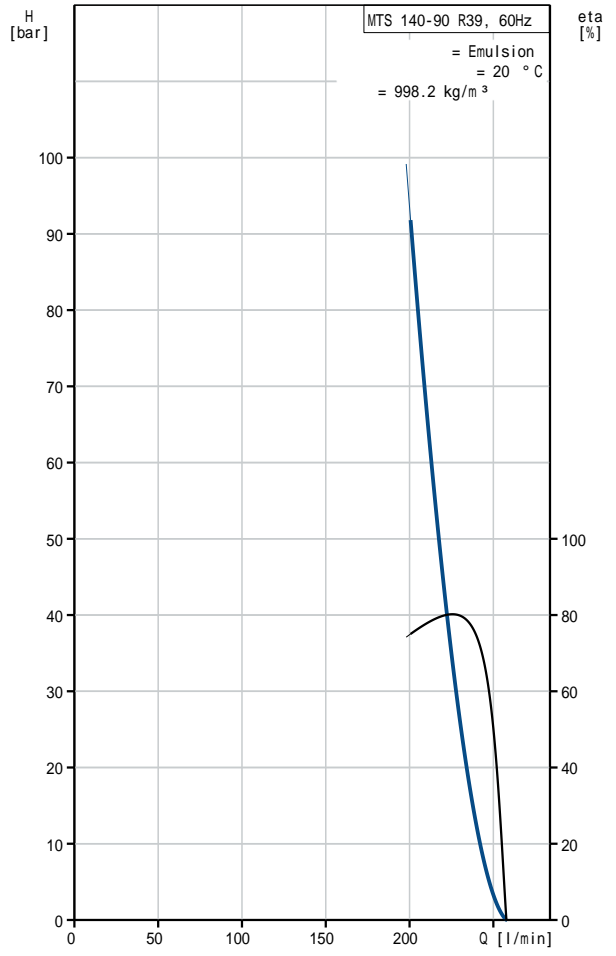

MTS 140-90 R39 D8.6 60 Hz

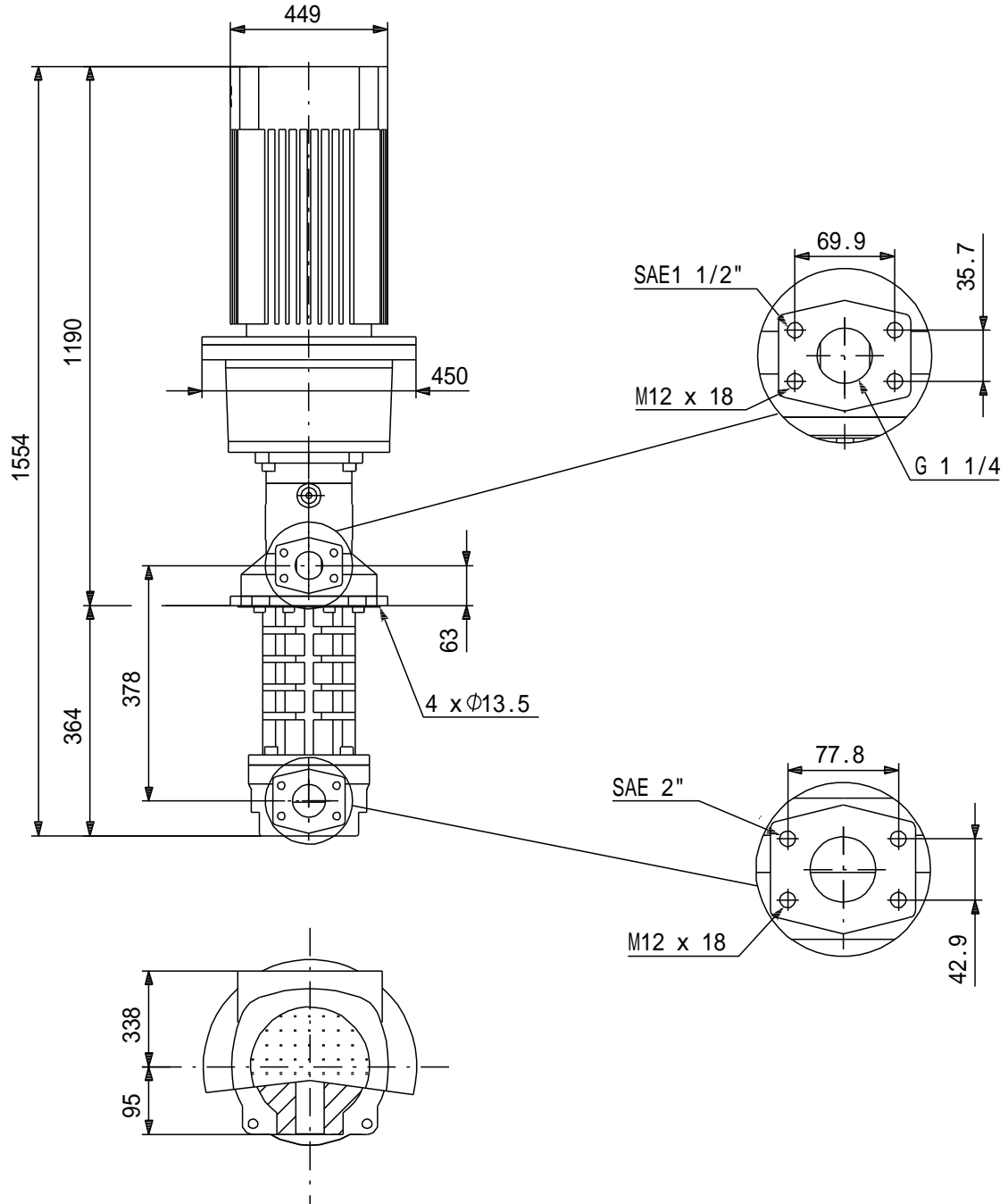

!

[mm]

MTS 140-90 R39 D8.6 60 Hz



IEC TP211 THERMALLY PROTECTED WHEN THE THERMISTORS ARE
CONNECTED TO AMPLIFIER RELAY FOR CONTROL OF MAIN SUPPLY
THERMISTORS PTC ACCORDING TO DIN 44082