

1 MTS 140-40 R46 D8.6



Screw spindle pump designed for pumping of cooling lubricants and cutting oils water/oil emulsion min. 3% for machine tool applications. The pump is designed to be mounted on top of tanks with pump immersed in the pumped liquid.

The pump has the following characteristics:

- High efficiency ensures very low heat input into the cooling lubricant.
- Axial thrust completely neutralised hydrostatically.
- Very wear resistant due specially hardened surfaces.
- D8.6 - mechanical shaft seal according to EN 12756.
- Power transmission via cast iron flexible coupling.

The motor is a 3-phase AC motor.

:	:	Emulsion
:	:	80 °C
:	:	20 °C
:	:	998.2 kg/m ³
:	:	
:	가	: 3500 rpm
:	:	289 l/min
1	:	D8.6
가:	:	CE
:	:	
:	:	55 °C
:	:	40 bar
:	:	SAE 2"
:	:	G 1 1/4" / SAE 1 1/2"
:	:	0 mm
:	:	FF350
:	:	
IE	:	SIEMENS
:	:	NEMA Premium / IE3 60Hz
- P2:	:	30 kW
(P2):	:	23.7 kW
:	:	60 Hz
:	:	3 x 380-420D/660-725Y V
:	:	56,0-50,0/32,0-29,0 A
:	:	610-610 %
cos phi -	:	0.89
:	:	3545 rpm

:	:	IE3 92,4%
	:	92.4-92.4 %
3/4	:	92.8-92.8 %
1/2	:	92.5-92.5 %
:	:	2
(IEC 34-5):	:	55 Dust/Jetting
(IEC 85):	:	F
:	:	
:	:	317 kg

MTS 140-40 R46 D8.6 60 Hz

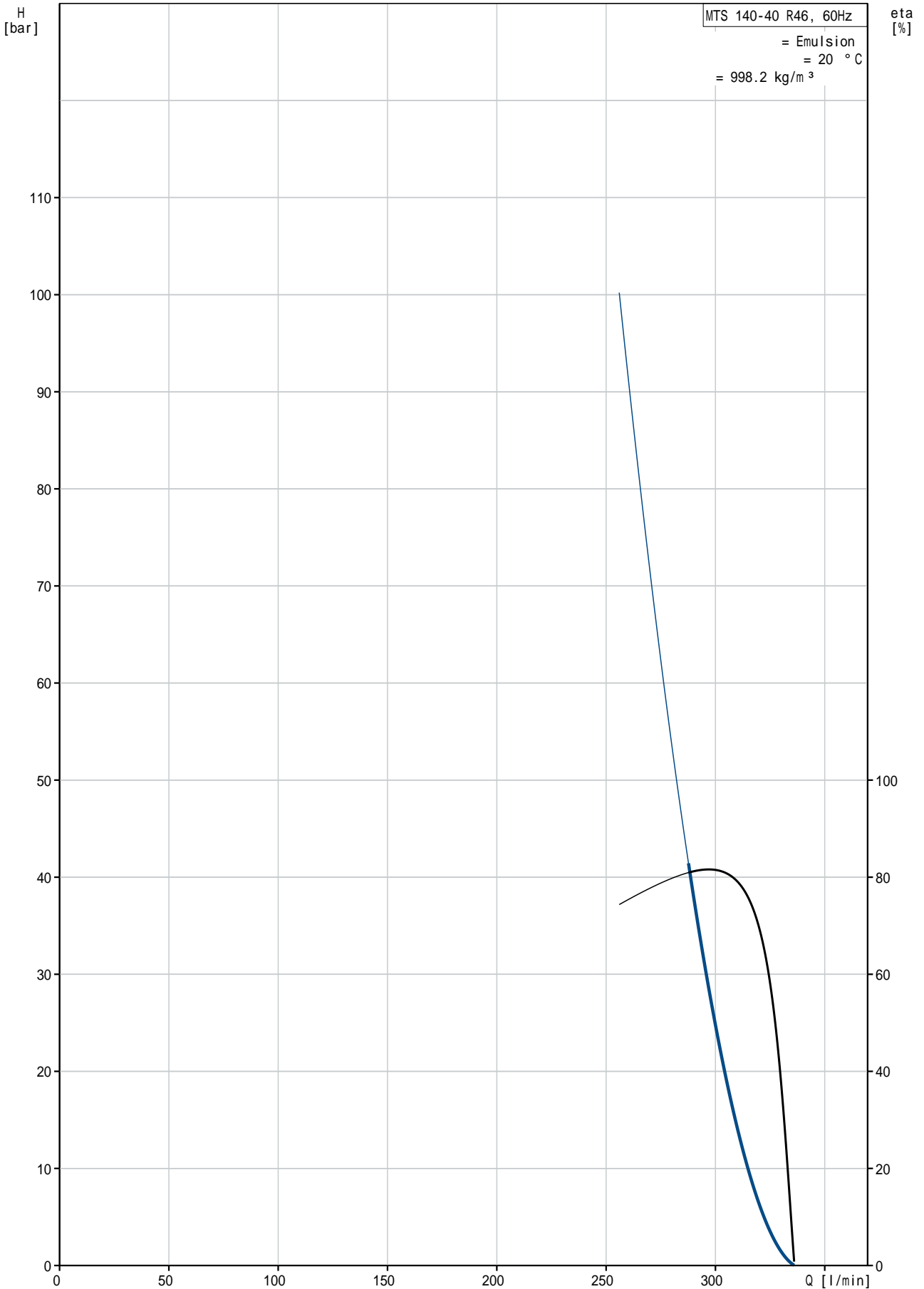

MTS 140-40 R46 D8.6	
EAN	
가	3500 rpm
	289 l/min
1	D8.6
가:	CE
	A
	55 °C
	40 bar
	SAE 2"
	G 1 1/4" / SAE 1 1/2"
	0 mm
	FF350
	DRY
	Emulsion
	80 °C
	20 °C
	998.2 kg/m ³
	SIEMENS
IE	NEMA Premium / IE3 60Hz
- P2:	30 kW
(P2):	23.7 kW
	60 Hz
	3 x 380-420D/660-725Y V
	56,0-50,0/32,0-29,0 A
	610-610 %
cos phi -	0.89
	3545 rpm
	IE3 92,4%
	92.4-92.4 %
3/4	92.8-92.8 %
1/2	92.5-92.5 %
	2
(IEC 34-5):	55 Dust/Jetting
(IEC 85):	F
	PTC
	83U15232
Pos term	12 o'clock
	317 kg
	3 %
	46

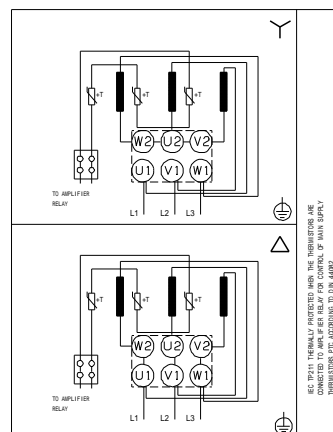
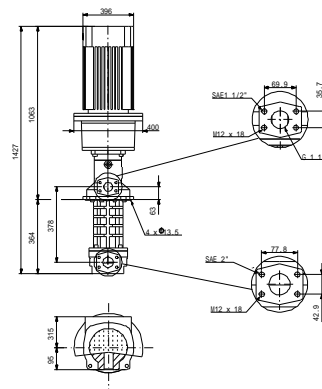
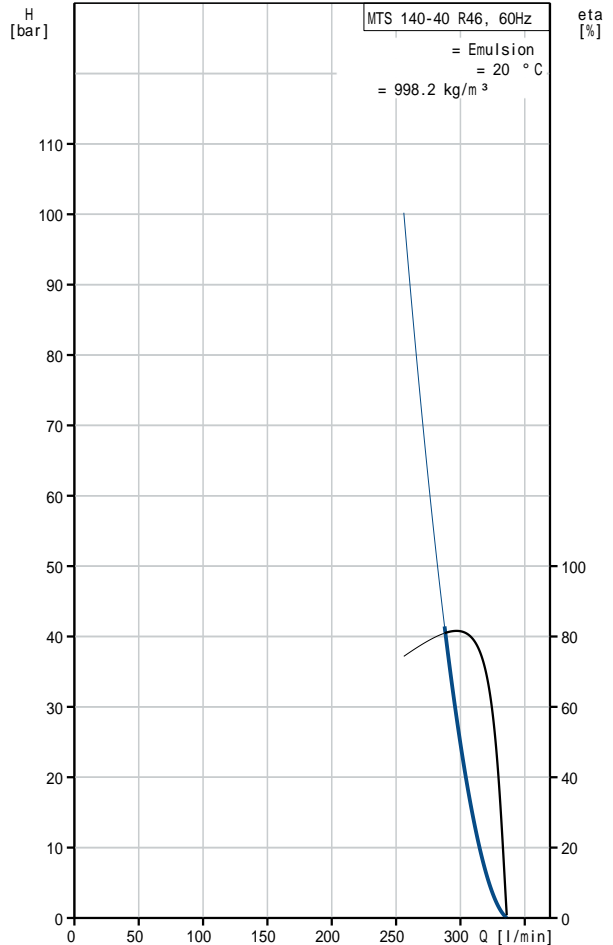

MTS 140-40 R46 D8.6 60 Hz

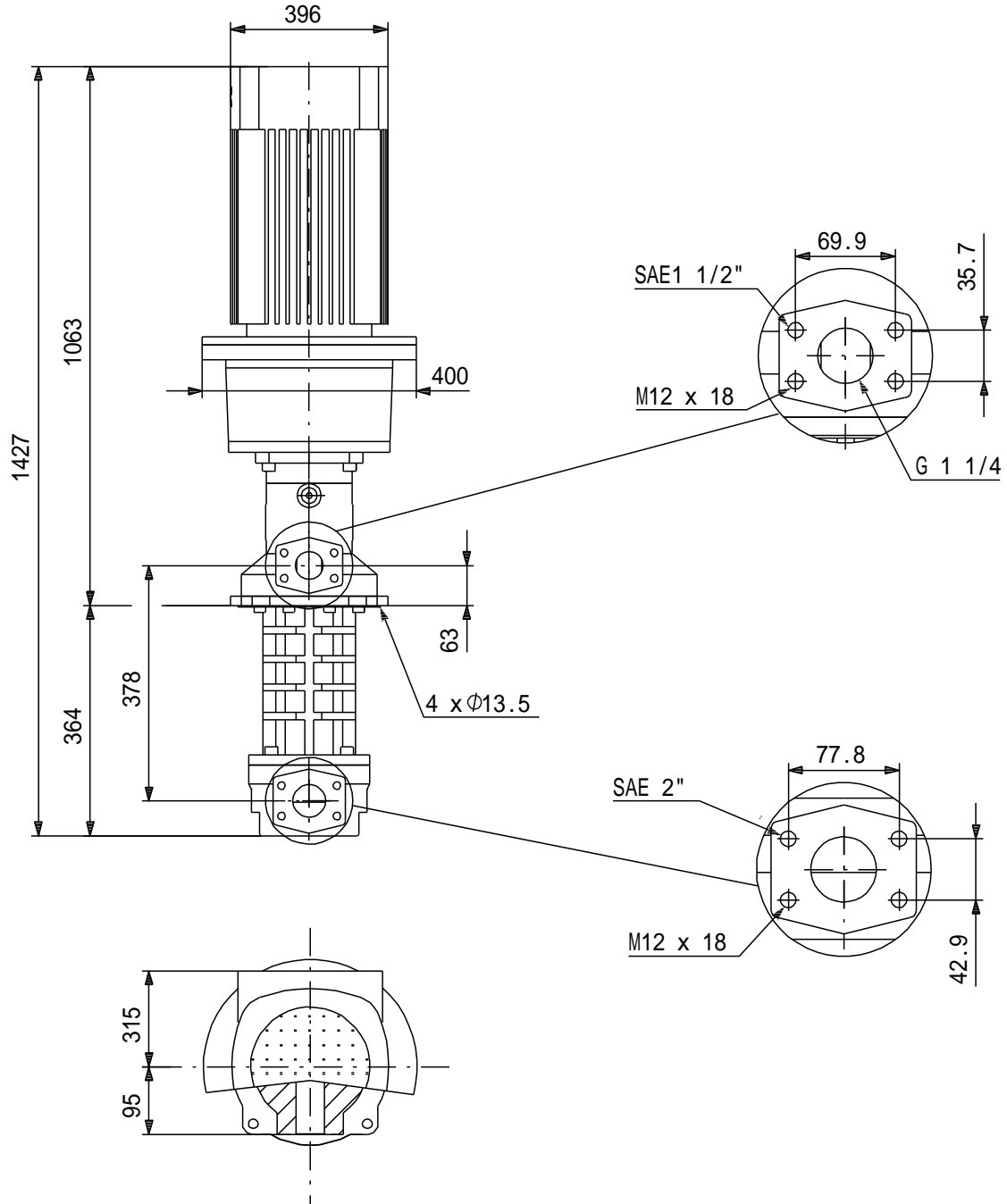

!

[mm]

MTS 140-40 R46 D8.6 60 Hz

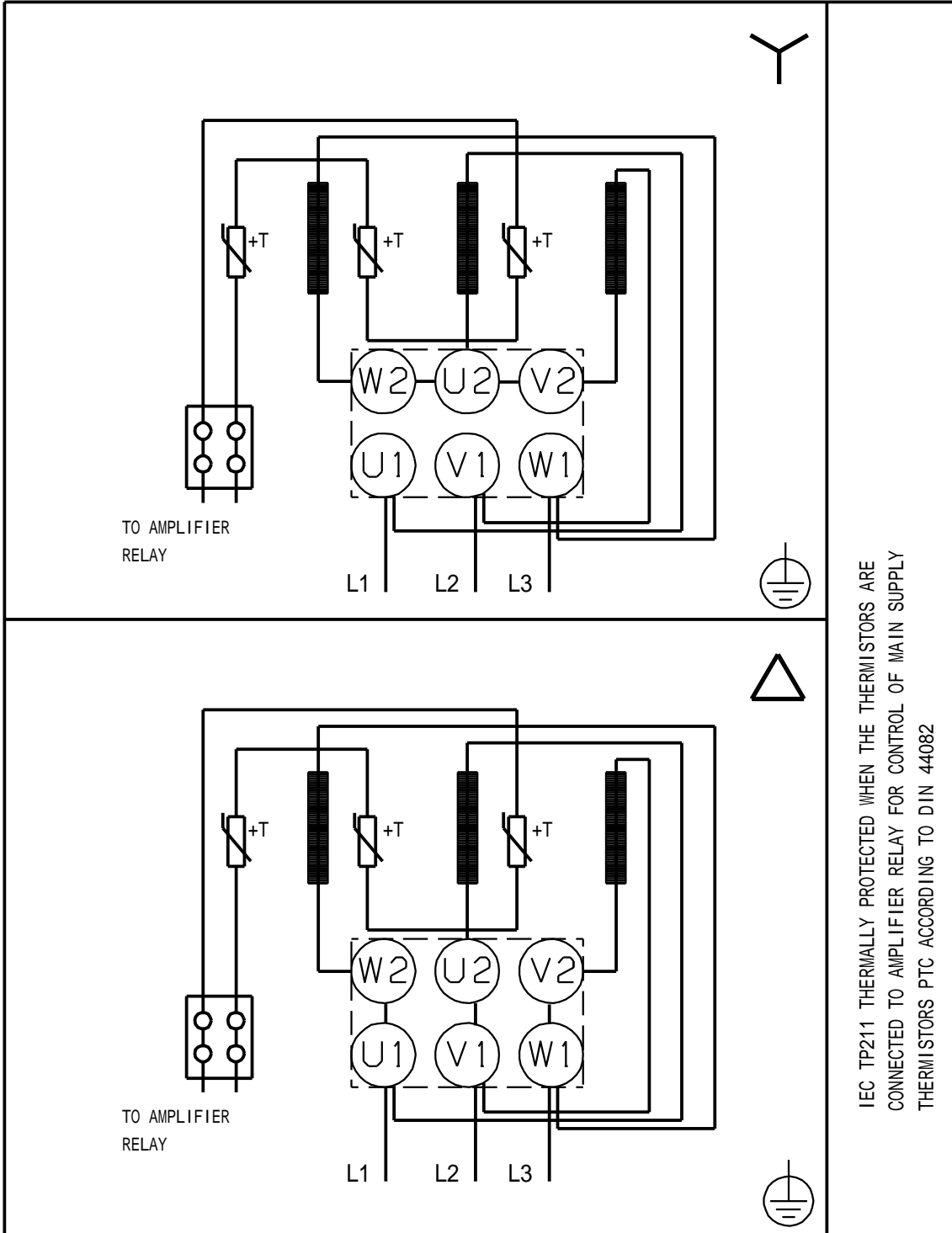

IEC TP211 THERMALLY PROTECTED WHEN THE THERMISTORS ARE
CONNECTED TO AMPLIFIER RELAY FOR CONTROL OF MAIN SUPPLY
THERMISTORS PTC ACCORDING TO DIN 44082